

# MOBILI RE

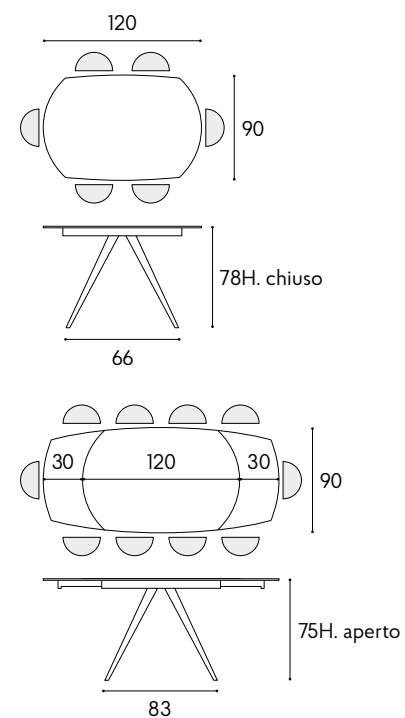





**articolo 1919**  
tavolo allungabile. top in ceramica spessore 10 mm. gambe in metallo colore bianco. allunghe interne in ceramica da cm. 30.  
*extendable table. 10 mm thick ceramic top. legs in white metal. internal extensions in ceramic cm. 30.*  
cm. l. 120 p. 90 h. 78 colli 2 - m<sup>3</sup> 0,43  
aperto. *open. 180 x 90 x h.75 cm.*



**articolo 07**  
sedia struttura in metallo imbottita in ecopelle antracite. *chair with metal frame upholstered in anthracite eco-leather.*  
cm. l. 40 p. 47 h. 82 h.s. 52  
non impilabile. *not stackable.*  
colli 1 - imballo 2 pz. - m<sup>3</sup> 0,20

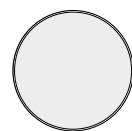

**articolo 1761**  
specchiera rotonda cornice in metallo specchio fumè. *round mirror with fumè mirror metal frame.*  
cm. ø. 90 colli 1 - m<sup>3</sup> 0,13



particolare piano finitura bianco statuario. *detailed top in statuary white finishing.*

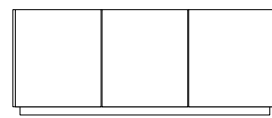

**articolo 1827**  
madia 3 ante ammortizzate struttura grigio cemento piano finitura bianco statuario. *3 amortized doors sideboard cement gray structure top in statuary white finishing.*  
cm. l. 200 p. 50 h. 79 colli 2 - m<sup>3</sup> 0,16





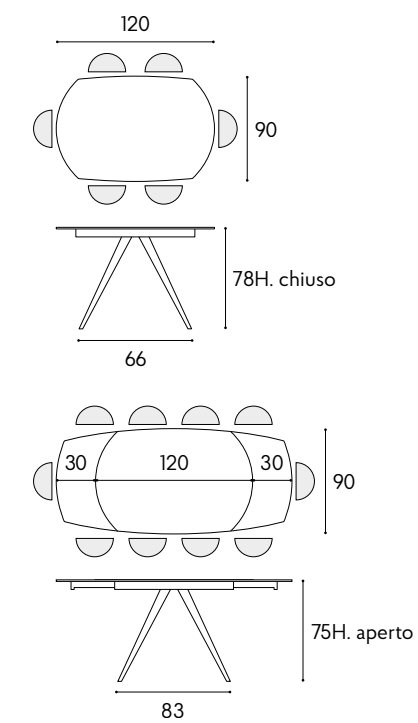

articolo **1919**  
 tavolo allungabile. top in ceramica spessore 10 mm. gambe in metallo colore bianco. allunghe interne in ceramica da cm. 30.  
*extendable table. 10 mm thick ceramic top. legs in white metal. internal extensions in ceramic cm. 30.*  
 cm. l. 120 p. 90 h. 78 colli 2 - m<sup>3</sup> 0,43  
 aperto. *open.* 180 x 90 x h.75 cm.



articolo **07**  
 sedia struttura in metallo imbottita in ecopelle antracite. *chair with metal frame upholstered in anthracite eco-leather.*  
 cm. l. 40 p. 47 h. 82 h.s. 52  
 non impilabile. *not stackable.*  
 colli 1 - imballo 2 pz. - m<sup>3</sup> 0,20





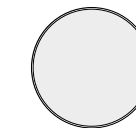

articolo **1761**  
specchiera rotonda cornice  
in metallo specchio fumè. *round mirror  
with fumè mirror metal frame.*  
cm. ø. 90 colli 1 - m³ 0,13

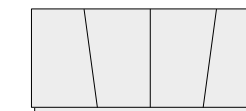

articolo **1828**  
madia 4 ante ammortizzate finitura  
acciaio ossidato. *4 amortized doors  
sideboard oxidized steel finishing.*  
cm. l. 180 p. 50 h. 79 colli 2 - m³ 0,21

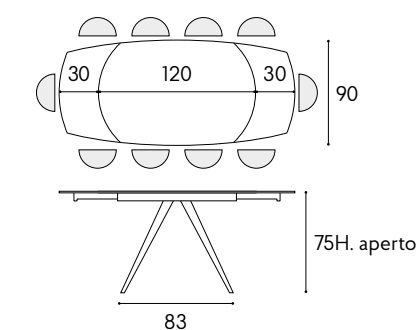
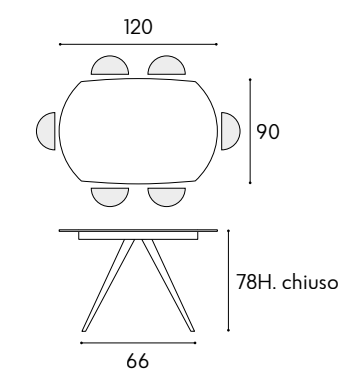

articolo **1920**  
tavolo allungabile. top in ceramica grigio  
graffite spessore 10 mm. gambe in metallo  
colore antracite. allunghe interne in ceramica  
grigio graffite cm. 30. *extendable table.  
10 mm thick graphite gray ceramic top.  
legs in anthracite-colored metal. internal  
extensions in graphite gray ceramic cm. 30.*  
cm. l. 120 p. 90 h. 78 colli 2 - m³ 0,43  
aperto. *open.* 180 x 90 x h.75 cm.

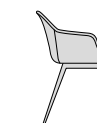

articolo **04**  
sedia struttura in metallo imbottita in  
ecopelle antracite. *chair with metal frame  
upholstered in anthracite eco-leather.*  
cm. l. 43 p. 60 h. 83 h.s. 45  
non impilabile. *not stackable.*  
colli 1 - imballo 2 pz. - m³ 0,24



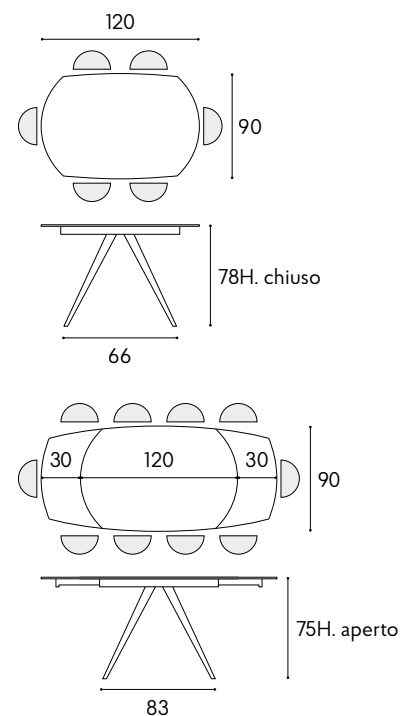

articolo **1920**  
tavolo allungabile. top in ceramica grigio graffite spessore 10 mm. gambe in metallo colore antracite. allunghe interne in ceramica grigio graffite cm. 30. *extendable table. 10 mm thick graphite gray ceramic top. legs in anthracite-colored metal. internal extensions in graphite gray ceramic cm. 30.* cm. l. 120 p. 90 h. 78 colli 2 - m<sup>3</sup> 0,43 aperto. *open. 180 x 90 x h.75 cm.*



*The extendable table perfect for every closed need measures 120, with both extensions arrives to 180 cm. Graphite gray ceramic top 10 mm thick. Modern, slender but solid table, with a linear and clean design, therefore perfect both in the kitchen and in the dining room. A modern space-saving table to be opened on occasion or to always be left open, we are sure that you will be really satisfied.*

Il tavolo allungabile perfetto per ogni esigenza da chiuso misura 120, con entrambe le allunghe arriva a 180 cm. Top in ceramica grigio graffite spessore 10 mm. Tavolo moderno, snello ma solido, dal design lineare e pulito, quindi perfetto sia in cucina che in sala da pranzo. Un tavolo moderno salvaspazio da aprire all'occasione o da lasciare sempre aperto, siamo sicuri che ne resterai davvero soddisfatto.



articolo **1828**  
madia 4 ante ammortizzate finitura acciaio ossidato. *4 amortized doors sideboard oxidized steel finishing.* cm. l. 180 p. 50 h. 79 colli 2 - m<sup>3</sup> 0,21



articolo **04**  
sedia struttura in metallo imbottita in ecopelle antracite. *chair with metal frame upholstered in anthracite eco-leather.* cm. l. 43 p. 60 h. 83 h.s. 45 non impilabile. *not stackable.* colli 1 - imballo 2 pz. - m<sup>3</sup> 0,24



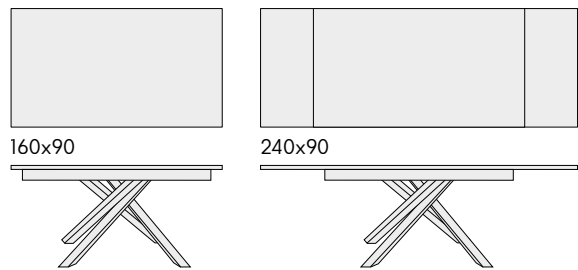
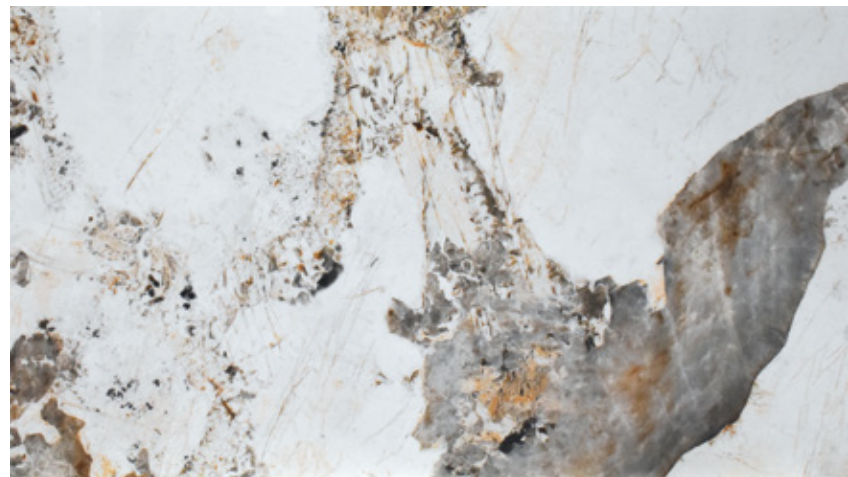

articolo **1759**  
 tavolo allungabile con base in metallo bianco  
 e piano finitura luxury pandora 2 allunghe laterali cm. 40.  
*extendable table with metal base white  
 and pandora luxury finish top 2 side extensions cm. 40.*  
 cm. l. 160 p. 90 h. 76 colli 2 - m<sup>3</sup> 0,34  
 aperto. open. 240 x 90

particolare piano finitura luxury pandora.  
*detailed top in pandora luxury finishing.*



articolo **1914**  
 sedia struttura in metallo imbottita  
 in velluto grigio. *chair with metal structure  
 upholstered in gray velvet.*  
 cm. l. 43 p. 48 h. 84 h.s. 46  
 non impilabile. *not stackable.*  
 colli 1 - imballo 2 - pz. m<sup>3</sup> 0,32







particolare piano finitura bianco statuario.  
detailed top in statuary white finishing.

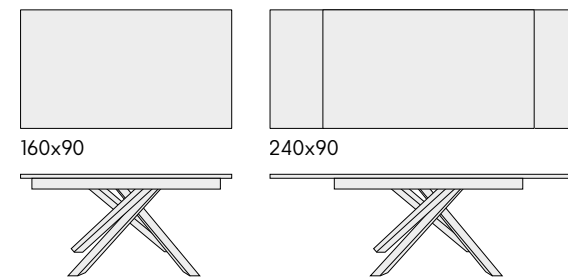

articolo **1758**  
tavolo allungabile con base in metallo  
bianco e piano finitura bianco statuario  
2 allunghe laterali cm. 40.  
extendable table with metal base  
white and statuary white finish top  
2 side extensions cm. 40.  
cm. l. 160 p. 90 h. 76 colli 2 - m<sup>3</sup> 0,34  
aperto. open. 240 x 90



articolo **1915**  
sedia struttura in metallo imbottita  
in velluto grigio. chair with metal structure  
upholstered in gray velvet.  
cm. l. 53 p. 63 h. 84 h.s. 46  
non impilabile. not stackable.  
colli 2 - imballo 4 pz. - m<sup>3</sup> 0,47





particolare piano finitura bianco statuario.  
detailed top in statuary white finishing.

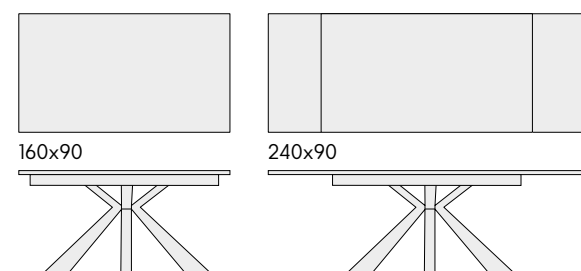

articolo **1927**  
tavolo allungabile con base in metallo colore antracite e piano finitura bianco statuario 2 allunghe laterali cm. 40.  
extendable table with metal base anthracite color and statuary white finish top 2 side extensions cm. 40.  
cm. l. 160 p. 90 h. 76 colli 2 - m<sup>3</sup> 0,42  
aperto. open. 240 x 90



particolare piano finitura bianco statuario. detailed top in statuary white finishing.

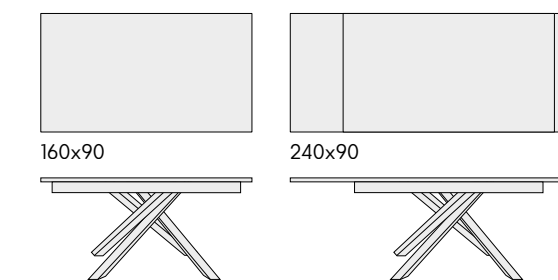

articolo **1928**  
tavolo allungabile con base in metallo colore antracite e piano finitura bianco statuario 2 allunghe laterali cm. 40.  
extendable table with metal base anthracite color and statuary white finish top 2 side extensions cm. 40.  
cm. l. 160 p. 90 h. 76 colli 2 - m<sup>3</sup> 0,34  
aperto. open. 240 x 90



articolo **1914**  
sedia struttura in metallo imbottita in velluto grigio. chair with metal structure upholstered in gray velvet.  
cm. l. 43 p. 48 h. 84 h.s. 46  
non impilabile. not stackable.  
colli 1 - imballo 4 pz. - m<sup>3</sup> 0,32



articolo **1915**  
sedia struttura in metallo imbottita in velluto grigio. chair with metal structure upholstered in gray velvet.  
cm. l. 53 p. 63 h. 84 h.s. 46  
non impilabile. not stackable.  
colli 2 - imballo 4 pz. - m<sup>3</sup> 0,47



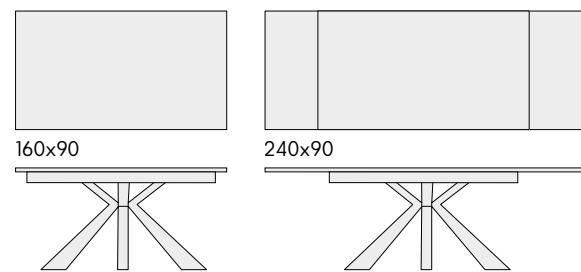

articolo **1757**  
 tavolo allungabile con base in metallo bianco  
 e piano finitura bianco statuario 2 allunghe laterali cm. 40.  
*extendable table with metal base white  
 and statuary white finish top 2 side extensions cm. 40.*  
 cm. l. 160 p. 90 h. 76 colli 2 - m<sup>3</sup> 0,42  
 aperto. open. 240 x 90



particolare piano finitura bianco statuario.  
*detailed top in statuary white finishing.*



articolo **1914**  
 sedia struttura in metallo imbottita  
 in velluto grigio. *chair with metal structure  
 upholstered in gray velvet.*  
 cm. l. 43 p. 48 h. 84 h.s. 46  
 non impilabile. *not stackable.*  
 colli 1 - imballo 4 pz. - m<sup>3</sup> 0,32





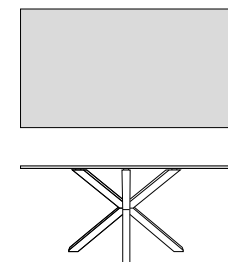

articolo **1754**  
tavolo fisso base in legno piano in vetro.  
*fixed table wooden base glass top.*  
cm. l. 160 p. 90 h. 75  
colli 2 - m<sup>3</sup> 0,15



articolo **1753**  
sedia struttura in legno seduta imbottita  
in tessuto. *chair with wooden structure  
upholstered seat in fabric*  
cm. l. 51 p. 55,5 h. 89 h.s. 45  
non impilabile. *not stackable.*  
colli 1 - imballo 2 pz. - m<sup>3</sup> 0,09





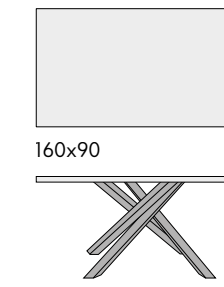

160x90

articolo **1916**  
cm. 160 x 90 h. 76 fisso. *fixed.*  
colli 2 - m<sup>3</sup> 0,13

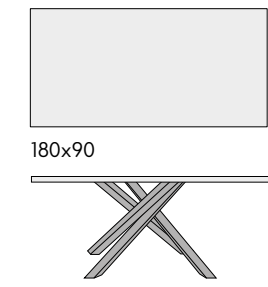

180x90

articolo **1917**  
cm. 180 x 90 h. 76 fisso. *fixed.*  
colli 2 - m<sup>3</sup> 0,14

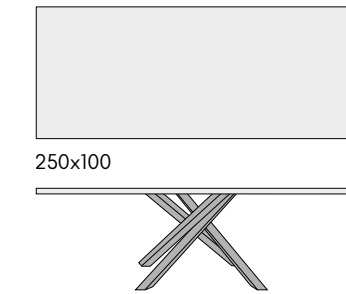

250x100

articolo **1918**  
cm. 250 x 100 h. 76 fisso. *fixed.*  
colli 2 - m<sup>3</sup> 0,19

tavolo base in metallo piano finitura  
rovere spessore 4 cm. *metal table base*  
with oak finish top thickness 4 cm.



articolo **695**  
sedia in polipropilene trasparente.  
*transparent polypropylene chair*  
cm. l. 50,5 p. 48,5 h. 94 h.s. 46  
impilabile. *stackable.*  
colli 1 - imballo 4 pz. - m<sup>3</sup> 0,30





70x70

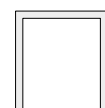

articolo **1892** cm. 70 x 70 h. 74  
colli 1 - m<sup>3</sup> 0,36



80x80



articolo **1893** cm. 80 x 80 h. 74  
colli 1 - m<sup>3</sup> 0,47

tavolino bar autolivellante finitura grigio  
antracite impilabile. *stackable self-leveling  
bar table with anthracite gray finish.*



articolo **969**  
sedia struttura e seduta in polipropilene  
colore bianco. *chair structure and seat  
in polypropylene white color.*  
cm. l. 50 p. 53 h. 81 h.s. 46  
impilabile. *stackable.*  
colli 1 - imballo 4 pz. - m<sup>3</sup> 0,24



articolo **970**  
sedia struttura e seduta in polipropilene  
colore grigio. *chair structure and seat  
in polypropylene gray color.*  
cm. l. 50 p. 53 h. 81 h.s. 46  
impilabile. *stackable.*  
colli 1 - imballo 4 pz. - m<sup>3</sup> 0,24



articolo **971**  
sedia struttura e seduta in polipropilene  
colore tortora. *chair structure and seat  
in polypropylene taupe color.*  
cm. l. 50 p. 53 h. 81 h.s. 46  
impilabile. *stackable.*  
colli 1 - imballo 4 pz. - m<sup>3</sup> 0,24







160x90

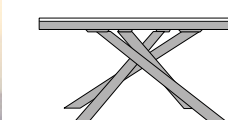

tavolo allungabile base in metallo piano  
finitura bianco statuario. *extendable table  
metal base top in white statuary finishing.*

articolo **1764** cm. 120 x 80 l allunga  
laterale cm. 50. *1 side extension cm. 50.*  
aperto. *open.* 170 x 80 h. 77  
colli 3 - m<sup>3</sup> 0,18



220x90

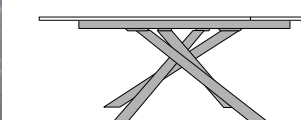

articolo **1765** cm. 140 x 80 l allunga  
laterale cm. 60. *1 side extension cm. 60.*  
aperto. *open.* 200 x 80 h. 77  
colli 3 - m<sup>3</sup> 0,20

articolo **1766** cm. 160 x 90 l allunga  
laterale cm. 60. *1 side extension cm. 60.*  
aperto. *open.* 220 x 90 h. 77  
colli 3 - m<sup>3</sup> 0,25

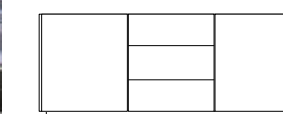

articolo **1760**

madia 2 ante ammortizzate 3 cassetti struttura  
acciaio ossidato piano finitura bianco statuario.  
*2 amortized doors sideboard 3 drawers oxidized  
steel structure top in statuary white finishing.*  
cm. l. 200 p. 50 h. 79  
colli 2 - m<sup>3</sup> 0,22



articolo **07**

sedia struttura in metallo imbottita in  
ecopelle antracite. *chair with metal frame  
upholstered in anthracite eco-leather.*  
cm. l. 40 p. 47 h. 82 h.s. 52  
non impilabile. *not stackable.*  
colli 1 - imballo 2 pz. - m<sup>3</sup> 0,20

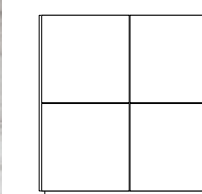

articolo **1762**

contenitore 4 ante ammortizzate struttura  
acciaio ossidato piano finitura bianco statuario.  
*4 amortized doors cupboard oxidized steel  
structure, top in statuary white finishing.*  
cm. l. 136 p. 50 h. 140  
colli 2 - m<sup>3</sup> 0,16



articolo **10**

Sgabello struttura in metallo imbottita  
in ecopelle antracite. *Stool with metal frame  
upholstered in anthracite eco-leather.*  
cm. l. 36 p. 44 h. 100 h.s. 76  
non impilabile. *not stackable.*  
colli 1 - imballo 2 pz. - m<sup>3</sup> 0,22



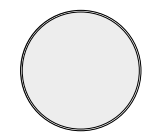

articolo **1761**  
specchiera rotonda cornice  
in metallo specchio fumè. *round mirror*  
*with fumè mirror metal frame.*  
cm. ø. 90 colli 1 - m<sup>3</sup> 0,13

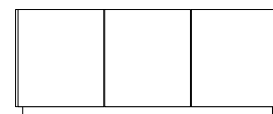

articolo **1767**  
madia 3 ante ammortizzate struttura  
acciaio ossidato piano finitura bianco  
statuario. *3 amortized doors*  
*sideboard oxidized steel*  
*structure, top in statuary white*  
*finishing.*  
cm. l. 200 p. 50 h. 79 colli 2 - m<sup>3</sup> 0,22

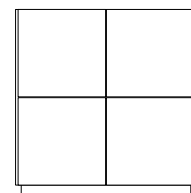

articolo **1762**  
contenitore 4 ante ammortizzate struttura  
acciaio ossidato piano finitura bianco  
statuario. *4 amortized doors*  
*cupboard oxidized steel*  
*structure, top in statuary white*  
*finishing.*  
cm. l. 136 p. 50 h. 140 colli 2 - m<sup>3</sup> 0,16

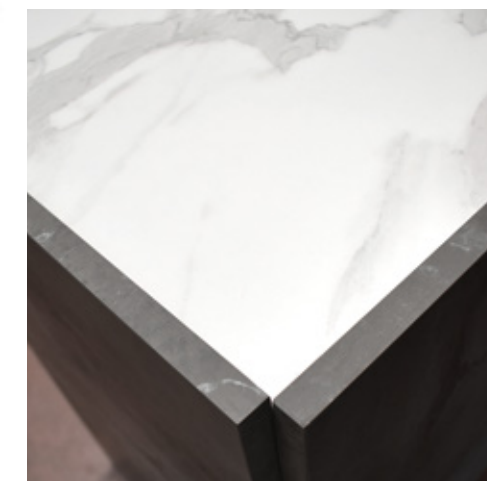
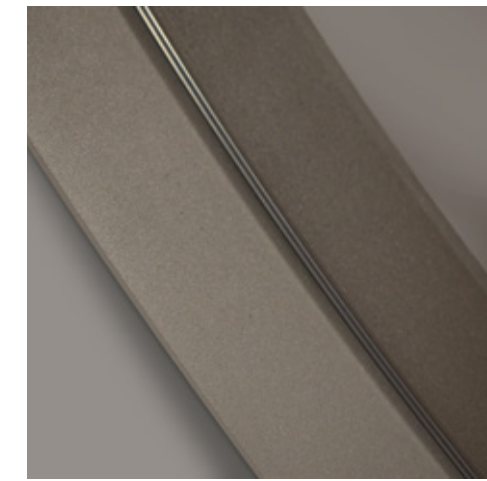



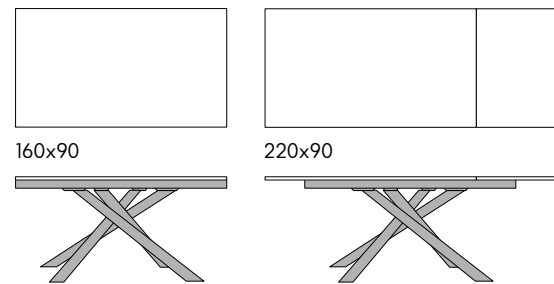

tavolo allungabile base in metallo piano  
finitura rovere rustico. *extendable table  
metal base top in rustic oak wood finishing.*

articolo **1768** cm. 120 x 80 l allunga  
laterale cm. 50. *l side extension cm. 50.*  
aperto. *open.* 170 x 80 h. 77  
colli 3 - m<sup>3</sup> 0,18

articolo **1769** cm. 140 x 80 l allunga  
laterale cm. 60. *l side extension cm. 60.*  
aperto. *open.* 200 x 80 h. 77  
colli 3 - m<sup>3</sup> 0,20

articolo **1770** cm. 160 x 90 l allunga  
laterale cm. 60. *l side extension cm. 60.*  
aperto. *open.* 220 x 90 h. 77  
colli 3 - m<sup>3</sup> 0,25

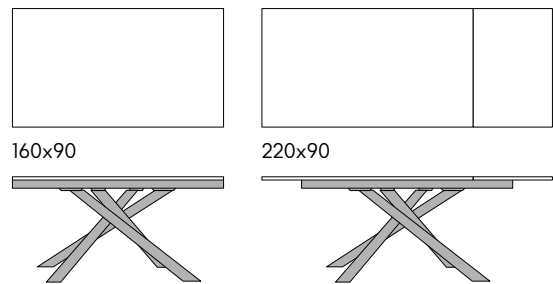

tavolo allungabile base in metallo piano  
finitura grigio cemento. *extendable table  
metal base top in cement gray finishing.*

articolo **1771** cm. 120 x 80 l allunga  
laterale cm. 50. *l side extension cm. 50.*  
aperto. *open.* 170 x 80 h. 77  
colli 3 - m<sup>3</sup> 0,18

articolo **1772** cm. 140 x 80 l allunga  
laterale cm. 60. *l side extension cm. 60.*  
aperto. *open.* 200 x 80 h. 77  
colli 3 - m<sup>3</sup> 0,20

articolo **1773** cm. 160 x 90 l allunga  
laterale cm. 60. *l side extension cm. 60.*  
aperto. *open.* 220 x 90 h. 77  
colli 3 - m<sup>3</sup> 0,25



articolo **07**  
sedia struttura in metallo imbottita in  
ecopelle antracite. *chair with metal frame  
upholstered in anthracite eco-leather.*  
cm. l. 40 p. 47 h. 82 h.s. 52  
non impilabile. *not stackable.*  
colli 1 - imballo 2 pz. - m<sup>3</sup> 0,20



articolo **07**  
sedia struttura in metallo imbottita in  
ecopelle antracite. *chair with metal frame  
upholstered in anthracite eco-leather.*  
cm. l. 40 p. 47 h. 82 h.s. 52  
non impilabile. *not stackable.*  
colli 1 - imballo 2 pz. - m<sup>3</sup> 0,20





160x90

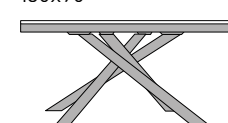

220x90

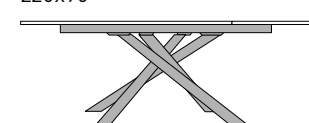

tavolo allungabile base in metallo piano  
finitura rovere rustico. *extendable table  
metal base top in rustic oak wood finishing.*

articolo **1780** cm. 120 x 80 1 allunga  
laterale cm. 50. *1 side extension cm. 50.*  
aperto. *open.* 170 x 80 h. 77  
colli 3 - m<sup>3</sup> 0,18

articolo **1781** cm. 140 x 80 1 allunga  
laterale cm. 60. *1 side extension cm. 60.*  
aperto. *open.* 200 x 80 h. 77  
colli 3 - m<sup>3</sup> 0,20

articolo **1782** cm. 160 x 90 1 allunga  
laterale cm. 60. *1 side extension cm. 60.*  
aperto. *open.* 220 x 90 h. 77  
colli 3 - m<sup>3</sup> 0,25



articolo **711**  
sedia struttura in metallo imbottita  
in ecopelle nera. *chair with metal frame  
upholstered in black eco-leather.*  
cm. l. 43 p. 53 h. 92 h.s. 44  
impilabile. *stackable.*  
colli 1 - imballo 4 pz. - m<sup>3</sup> 0,30



160x90

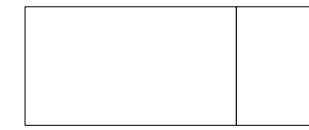
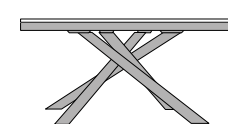

220x90

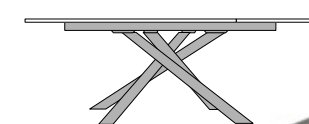

tavolo allungabile base in metallo piano  
finitura acciaio ossidato. *extendable table  
metal base top in oxidized steel finishing.*

articolo **1774** cm. 120 x 80 1 allunga  
laterale cm. 50. *1 side extension cm. 50.*  
aperto. *open.* 170 x 80 h. 77  
colli 3 - m<sup>3</sup> 0,18

articolo **1775** cm. 140 x 80 1 allunga  
laterale cm. 60. *1 side extension cm. 60.*  
aperto. *open.* 200 x 80 h. 77  
colli 3 - m<sup>3</sup> 0,20

articolo **1776** cm. 160 x 90 1 allunga  
laterale cm. 60. *1 side extension cm. 60.*  
aperto. *open.* 220 x 90 h. 77  
colli 3 - m<sup>3</sup> 0,25



articolo **04**  
sedia struttura in metallo imbottita in  
ecopelle antracite. *chair with metal frame  
upholstered in anthracite eco-leather.*  
cm. l. 43 p. 60 h. 83 h.s. 45  
non impilabile. *not stackable.*  
colli 1 - imballo 2 pz. - m<sup>3</sup> 0,24



160x90

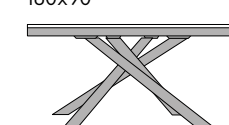

220x90

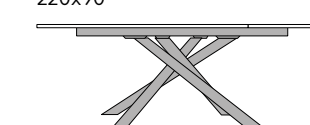

tavolo allungabile base in metallo piano  
finitura bianco frassinato. *extendable table  
metal base top in ash wood white finishing.*

articolo **1777** cm. 120 x 80 1 allunga  
laterale cm. 50. *1 side extension cm. 50.*  
aperto. *open.* 170 x 80 h. 77  
colli 3 - m<sup>3</sup> 0,18

articolo **1778** cm. 140 x 80 1 allunga  
laterale cm. 60. *1 side extension cm. 60.*  
aperto. *open.* 200 x 80 h. 77  
colli 3 - m<sup>3</sup> 0,20

articolo **1779** cm. 160 x 90 1 allunga  
laterale cm. 60. *1 side extension cm. 60.*  
aperto. *open.* 220 x 90 h. 77  
colli 3 - m<sup>3</sup> 0,25



articolo **07**  
sedia struttura in metallo imbottita in  
ecopelle antracite. *chair with metal frame  
upholstered in anthracite eco-leather.*  
cm. l. 40 p. 47 h. 82 h.s. 52  
non impilabile. *not stackable.*  
colli 1 - imballo 2 pz. - m<sup>3</sup> 0,20





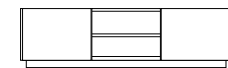

articolo **1783**  
 base TV 2 ante ammortizzate e 2 vani struttura  
 acciaio ossidato piano finitura bianco statuario.  
 2 amortized doors 2 comp. TV base oxidized  
 steel structure, top in statuary white finishing.  
 cm. l. 160 p. 45 h. 45 colli 2 - m<sup>3</sup> 0,13

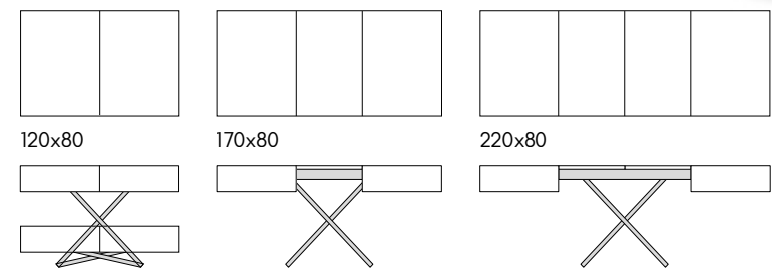

articolo **1784**  
 tavolino da salotto trasformabile  
 finitura acciaio ossidato base in metallo  
 con meccanismo e 2 allunghe da cm. 50  
 transformable coffee table oxidized  
 steel finishing metal base with mechanism  
 and 2 extensions of cm. 50  
 cm. l. 120 p. 80 h. 30/77 colli 1 - m<sup>3</sup> 0,37



cm. l. 220 p. 80 h. 77



cm. l. 120 p. 80 h. 77

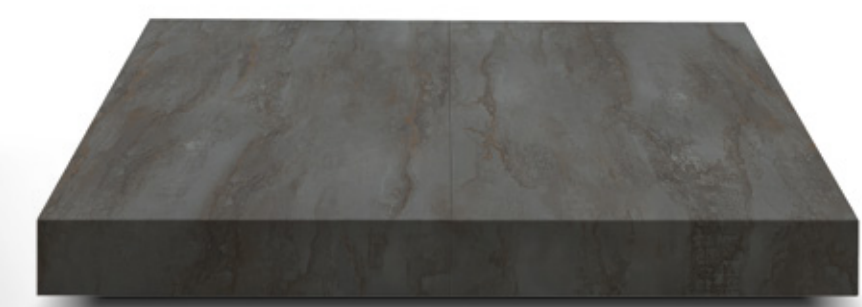

cm. l. 120 p. 80 h. 30



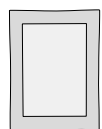

articolo **1787**  
specchiera rettangolare cornice  
in vetro effetto marmo. *rectangular mirror*  
*frame in marble effect glass.*  
cm. l. 68 h. 90 colli 1 - m<sup>3</sup> 0,05

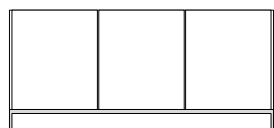

articolo **1786**  
madia 3 ante ammortizzate con piedi in  
metallo struttura acciaio ossidato piano  
finitura bianco statuario. *3 amortized doors*  
*sideboard with metal legs oxidized steel*  
*structure, top in statuary white finishing.*  
cm. l. 200 p. 50 h. 90 colli 3 - m<sup>3</sup> 0,40

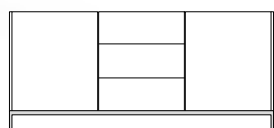

articolo **1785**  
madia 2 ante ammortizzate 3 cassetti con piedi  
in metallo struttura acciaio ossidato piano  
finitura bianco statuario. *2 amortized doors*  
*sideboard 3 drawers with metal legs oxidized*  
*steel structure top in statuary white finishing.*  
cm. l. 200 p. 50 h. 90 colli 3 - m<sup>3</sup> 0,40





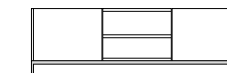

**articolo 1788**  
base TV 2 ante ammortizzate e 2 vani con  
piedi in metallo struttura acciaio ossidato piano  
finitura bianco statuario. 2 amortized doors  
2 comp. TV base with metal legs oxidized steel  
structure, top in statuary white finishing.  
cm. l. 160 p. 45 h. 51 colli 3 - m<sup>3</sup> 0,32

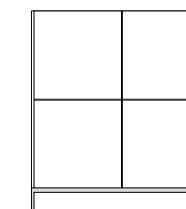

**articolo 1789**  
contenitore 4 ante ammortizzate con piedi  
in metallo struttura acciaio ossidato piano  
finitura bianco statuario. 4 doors amortized  
cupboard with metal legs oxidized steel  
structure, top in statuary white finishing.  
cm. l. 136 p. 50 h. 151 colli 3 - m<sup>3</sup> 0,29



**articolo 1790**  
tavolino rettangolare struttura in metallo  
piano acciaio ossidato. rectangular coffee  
table metal structure oxidized steel top.  
cm. l. 55 p. 90 h. 45 colli 1 - m<sup>3</sup> 0,03

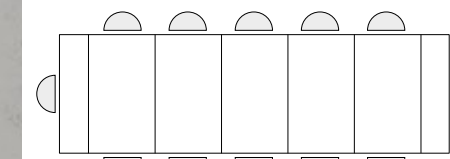

295x90

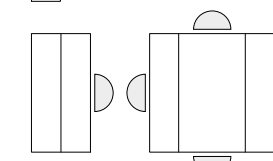
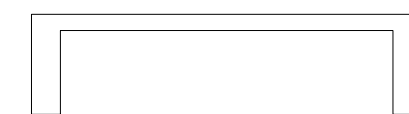

45x90

95x90

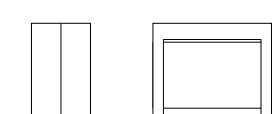

**articolo 1792**  
consolle allungabile con porta allunghe  
finitura acciaio ossidato e 5 allunghe  
da cm. 50. extendable console  
with extensions holder oxidized steel  
finishing and 5 extensions of cm. 50.  
cm. l. 90 p. 45 h. 76 colli 3 - m<sup>3</sup> 0,18





**articolo 1788**  
 base TV 2 ante ammortizzate e 2 vani con  
 piedi in metallo struttura acciaio ossidato piano  
 finitura bianco statuario. 2 amortized doors  
 2 comp. TV base with metal legs oxidized steel  
 structure, top in statuary white finishing.  
 cm. l. 160 p. 45 h. 51 colli 3 - m<sup>3</sup> 0,32



**articolo 1792**  
 consolle allungabile con porta allunghe  
 finitura acciaio ossidato e 5 allunghe  
 da cm. 50. extendable console  
 with extensions holder oxidized steel  
 finishing and 5 extensions of cm. 50.  
 cm. l. 90 p. 45 h. 76 colli 3 - m<sup>3</sup> 0,18

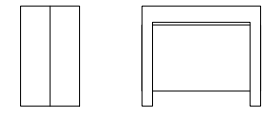
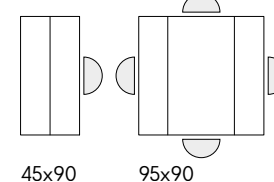
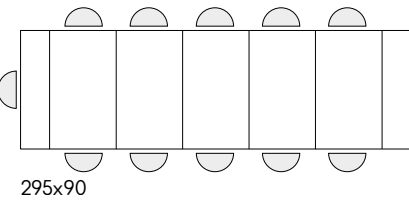

**articolo 713**  
 sedia struttura in metallo imbottita  
 in ecopelle grigia. chair with metal frame  
 upholstered in gray eco-leather.  
 cm. l. 43 p. 53 h. 92 h.s. 44  
 impilabile. stackable.  
 colli 1 - imballo 4 pz. - m<sup>3</sup> 0,30

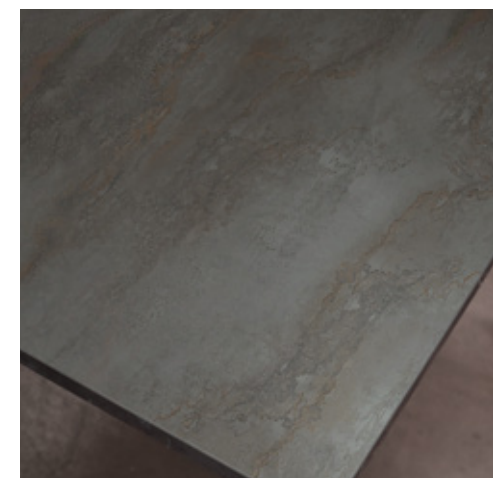
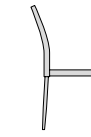

**articolo 1790**  
 tavolino rettangolare struttura in metallo  
 piano acciaio ossidato. rectangular coffee  
 table metal structure oxidized steel top.  
 cm. l. 55 p. 90 h. 45 colli 1 - m<sup>3</sup> 0,03

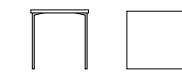

**articolo 1791**  
 tavolino quadrato struttura in metallo  
 piano acciaio ossidato. square coffee table  
 metal structure oxidized steel top.  
 cm. l. 55 p. 55 h. 45 colli 1 - m<sup>3</sup> 0,02

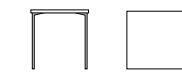



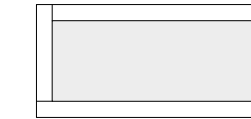

articolo **1793**  
Specchiera rettangolare con cornice  
grigio cemento. *rectangular mirror  
with cement gray frame.*  
cm. l. 177 h. 86 colli 1 - m<sup>3</sup> 0,12

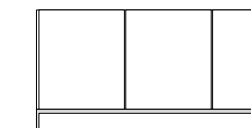

articolo **1794**  
madia 3 ante ammortizzate con piedi  
in metallo struttura grigio cemento piano  
finitura bianco statuario. *3 amortized doors  
sideboard with metal legs cement gray  
structure, top in statuary white finishing.*  
cm. l. 200 p. 50 h. 90 colli 3 - m<sup>3</sup> 0,40

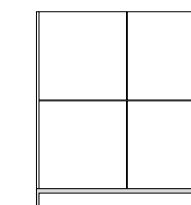

articolo **1795**  
contenitore 4 ante ammortizzate con piedi  
in metallo struttura grigio cemento piano  
finitura bianco statuario. *4 doors amortized  
cupboard with metal legs cement gray  
structure, top in statuary white finishing.*  
cm. l. 136 p. 50 h. 151 colli 3 - m<sup>3</sup> 0,29

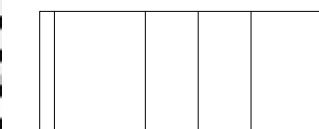

240x90

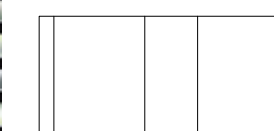
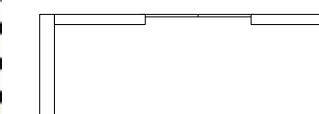

200x90

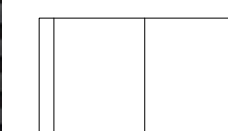
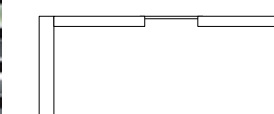

160x90

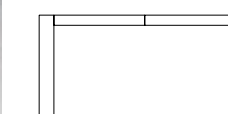

tavolo allungabile finitura grigio cemento.  
*extendable table cement gray finishing.*

articolo **1796** cm. 140 x 90 2 allunghe  
centrali cm. 40. *2 central extensions cm. 40.*  
aperto. *open.* 220 x 90 h. 77  
colli 2 - m<sup>3</sup> 0,38

articolo **1797** cm. 160 x 90 2 allunghe  
centrali cm. 40. *2 central extensions cm. 40.*  
aperto. *open.* 240 x 90 h. 77  
colli 2 - m<sup>3</sup> 0,38



articolo **713**  
sedia struttura in metallo imbottita  
in ecopelle grigia. *chair with metal frame  
upholstered in gray eco-leather.*  
cm. l. 43 p. 53 h. 92 h.s. 44  
impilabile. *stackable.*  
colli 1 - imballo 4 pz. - m<sup>3</sup> 0,30



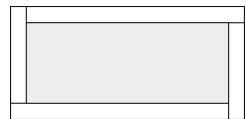

articolo **1793**  
Specchiera rettangolare con cornice  
grigio cemento. *rectangular mirror  
with cement gray frame.*  
cm. l. 177 h. 86 colli 1 - m<sup>3</sup> 0,12

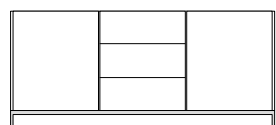

articolo **1798**  
madia 2 ante ammortizzate 3 cassetti con  
piedi in metallo struttura grigio cemento piano  
finitura bianco statuario. *2 amortized doors  
sideboard 3 drawers with metal legs cement  
gray structure, top in statuary white finishing.*  
cm. l. 200 p. 50 h. 90 colli 3 - m<sup>3</sup> 0,40

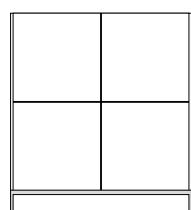

articolo **1795**  
contenitore 4 ante ammortizzate con piedi  
in metallo struttura grigio cemento piano  
finitura bianco statuario. *4 doors amortized  
cupboard with metal legs cement gray  
structure, top in statuary white finishing.*  
cm. l. 136 p. 50 h. 151 colli 3 - m<sup>3</sup> 0,29

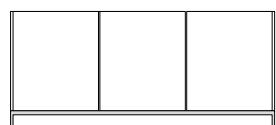

articolo **1794**  
madia 3 ante ammortizzate con piedi  
in metallo struttura grigio cemento piano  
finitura bianco statuario. *3 amortized doors  
sideboard with metal legs cement gray  
structure, top in statuary white finishing.*  
cm. l. 200 p. 50 h. 90 colli 3 - m<sup>3</sup> 0,40



*The BATTITO contemporary design collection defines the different living spaces,  
making each distinct without losing any of its unmistakable character.*

La collezione BATTITO contemporary design definisce e caratterizza con i suoi  
elementi le aree del giorno, non rinunciando al suo inconfondibile carattere.







articolo **713**  
 sedia struttura in metallo imbottita  
 in ecopelle grigia. *chair with metal frame*  
*upholstered in gray eco-leather.*  
 cm. l. 43 p. 53 h. 92 h.s. 44  
 impilabile. *stackable.*  
 colli 1 - imballo 4 pz. - m<sup>3</sup> 0,30

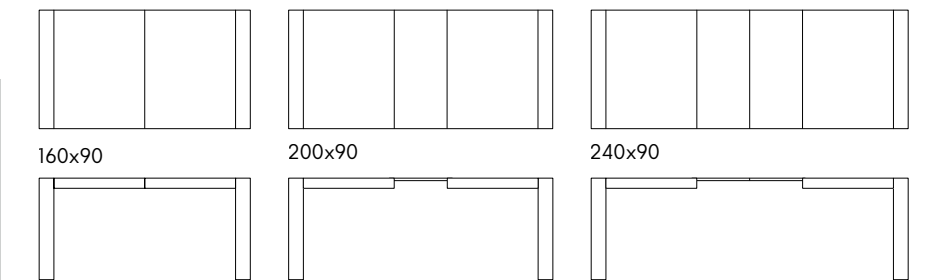

tavolo allungabile finitura grigio cemento.  
*extendable table cement gray finishing.*

articolo **1796** cm. 140 x 90 2 allunghe  
 centrali cm. 40. 2 *central extensions cm. 40.*  
 aperto. *open.* 220 x 90 h. 77  
 colli 2 - m<sup>3</sup> 0,38

articolo **1797** cm. 160 x 90 2 allunghe  
 centrali cm. 40. 2 *central extensions cm. 40.*  
 aperto. *open.* 240 x 90 h. 77  
 colli 2 - m<sup>3</sup> 0,38



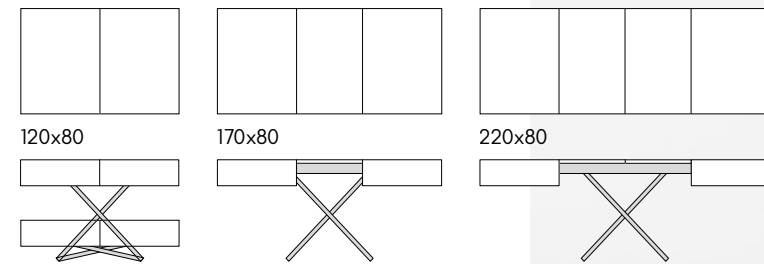

articolo **1823**  
 tavolino da salotto trasformabile  
 finitura grigio cemento base in metallo  
 con meccanismo e 2 allunghe da cm. 50  
*transformable coffee table cement gray  
 finishing metal base with mechanism  
 and 2 extensions of cm. 50*  
 cm. l. 120 p. 80 h. 30/77 colli 1 - m<sup>3</sup> 0,37



articolo **1822**  
 tavolino quadrato struttura in metallo  
 piano grigio cemento. *square coffee table  
 metal structure cement gray top.*  
 cm. l. 55 p. 55 h. 45 colli 1 - m<sup>3</sup> 0,02

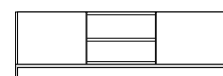

articolo **1820**  
 base TV 2 ante ammortizzate e 2 vani con  
 piedi in metallo struttura grigio cemento piano  
 finitura bianco statuario. *2 amortized doors  
 2 comp. TV base with metal legs cement gray  
 structure, top in statuary white finishing.*  
 cm. l. 160 p. 45 h. 51 colli 3 - m<sup>3</sup> 0,32

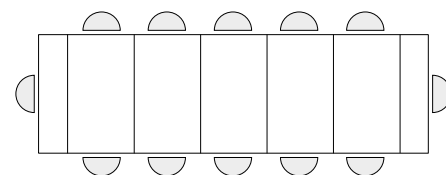

295x90

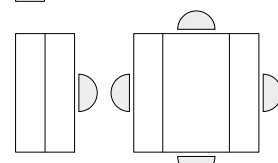
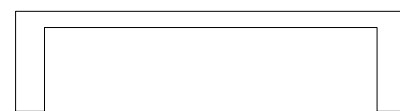

45x90

95x90

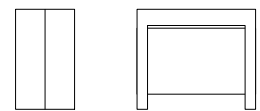

articolo **1819**  
 consolle allungabile con porta allunghe  
 finitura grigio cemento e 5 allunghe  
 da cm. 50. *extendable console  
 with extensions holder cement gray  
 finishing and 5 extensions of cm. 50.*  
 cm. l. 90 p. 45 h. 76 colli 3 - m<sup>3</sup> 0,18





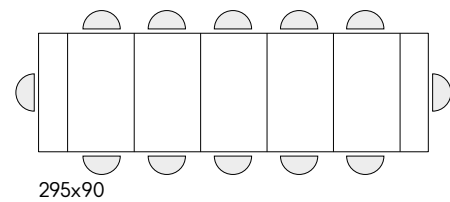

295x90

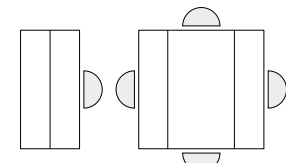

45x90 95x90

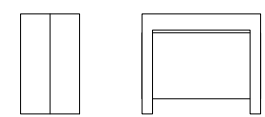

articolo **1819**  
consolle allungabile con porta allunghe  
finitura grigio cemento e 5 allunghe  
da cm. 50. *extendable console  
with extensions holder cement gray  
finishing and 5 extensions of cm. 50.*  
cm. l. 90 p. 45 h. 76 colli 3 - m<sup>3</sup> 0,18

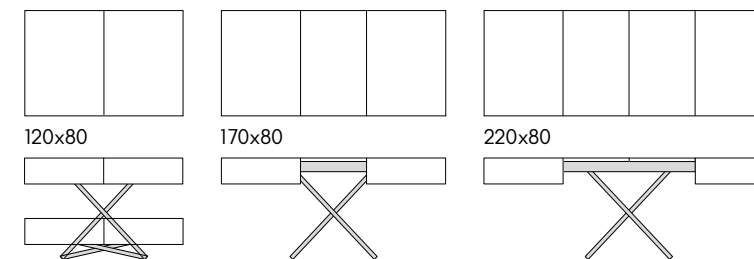

articolo **1823**  
tavolino da salotto trasformabile  
finitura grigio cemento base in metallo  
con meccanismo e 2 allunghe da cm. 50  
*transformable coffee table cement gray  
finishing metal base with mechanism  
and 2 extensions of cm. 50*  
cm. l. 120 p. 80 h. 30/77 colli 1 - m<sup>3</sup> 0,37

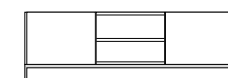

articolo **1820**  
base TV 2 ante ammortizzate e 2 vani con  
piedi in metallo struttura grigio cemento piano  
finitura bianco statuario. *2 amortized doors  
2 comp. TV base with metal legs cement gray  
structure, top in statuary white finishing.*  
cm. l. 160 p. 45 h. 51 colli 3 - m<sup>3</sup> 0,32



cm. l. 220 p. 80 h. 77



cm. l. 120 p. 80 h. 77



cm. l. 120 p. 80 h. 30



articolo **990**  
sedia struttura in metallo e seduta  
in polipropilene colore bianco.  
*chair with metal structure and seat  
in white color polypropylene.*  
cm. l. 52,5 p. 48 h. 88 h.s. 46  
non impilabile. *not stackable.*  
colli 1 - imballo 4 pz. - m<sup>3</sup> 0,16



articolo **1821**  
tavolino rettangolare struttura in metallo  
piano grigio cemento. *rectangular coffee  
table metal structure cement gray top.*  
cm. l. 55 p. 90 h. 45 colli 1 - m<sup>3</sup> 0,03



articolo **1822**  
tavolino quadrato struttura in metallo  
piano grigio cemento. *square coffee table  
metal structure cement gray top.*  
cm. l. 55 p. 55 h. 45 colli 1 - m<sup>3</sup> 0,02







**articolo 1793**  
Specchiera rettangolare con cornice grigio cemento. rectangular mirror with cement gray frame.  
cm. l. 177 h. 86 colli 1 - m<sup>3</sup> 0,12

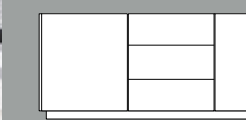
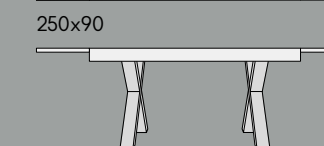
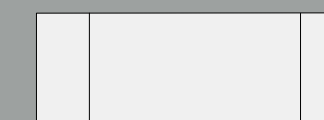

**articolo 1824**  
madia 2 ante ammortizzate 3 cassetti struttura grigio cemento piano finitura bianco statuario. 2 amortized doors sideboard 3 drawers cement gray structure top in statuary white finishing.  
cm. l. 200 p. 50 h. 79 colli 2 - m<sup>3</sup> 0,22

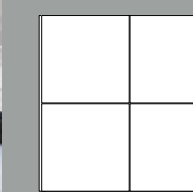
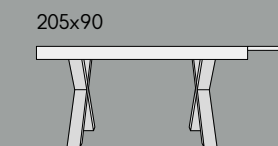
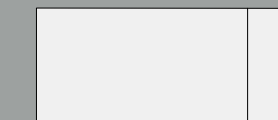

**articolo 1825**  
contenitore 4 ante ammortizzate struttura grigio cemento piano finitura bianco statuario. 4 amortized doors cupboard cement gray structure top in statuary white finishing.  
cm. l. 136 p. 50 h. 140 colli 2 - m<sup>3</sup> 0,16

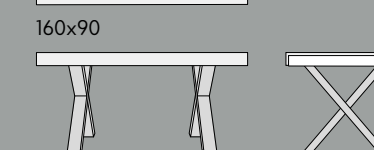
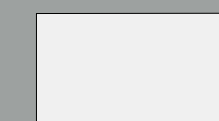

**articolo 1826**  
tavolo allungabile nobilitato piano finitura grigio cemento e base antracite 2 allunghe laterali cm. 45. extendable melamine table cement gray finishing top and anthracite base 2 extensions side cm. 45.  
cm. l. 160 p. 90 h. 77 colli 2 - m<sup>3</sup> 0,26 aperto. open. 250 x 90



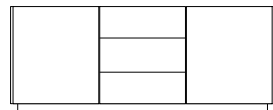

articolo **1824**  
 madia 2 ante ammortizzate 3 cassetti struttura  
 grigio cemento piano finitura bianco statuario.  
*2 amortized doors sideboard 3 drawers cement  
 gray structure top in statuary white finishing.*  
 cm. l. 200 p. 50 h. 79 colli 2 - m<sup>3</sup> 0,22

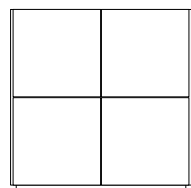

articolo **1825**  
 contenitore 4 ante ammortizzate struttura  
 grigio cemento piano finitura bianco statuario.  
*4 amortized doors cupboard cement gray  
 structure top in statuary white finishing.*  
 cm. l. 136 p. 50 h. 140 colli 2 - m<sup>3</sup> 0,16



articolo **1856**  
 base TV 2 ante ammortizzate e 2 vani struttura  
 grigio cemento piano finitura bianco statuario.  
*2 amortized doors 2 comp. TV base cement  
 gray structure top in statuary white finishing.*  
 cm. l. 160 p. 45 h. 45 colli 2 - m<sup>3</sup> 0,13

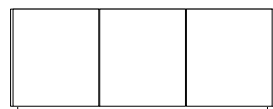

articolo **1827**  
 madia 3 ante ammortizzate struttura grigio  
 cemento piano finitura bianco statuario.  
*3 amortized doors sideboard cement gray  
 structure top in statuary white finishing.*  
 cm. l. 200 p. 50 h. 79 colli 2 - m<sup>3</sup> 0,16

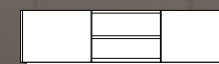

articolo **1856**  
 base TV 2 ante ammortizzate e 2 vani struttura  
 grigio cemento piano finitura bianco statuario.  
*2 amortized doors 2 comp. TV base cement  
 gray structure top in statuary white finishing.*  
 cm. l. 160 p. 45 h. 45 colli 2 - m<sup>3</sup> 0,13



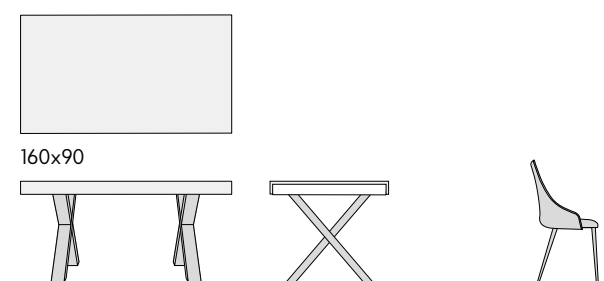
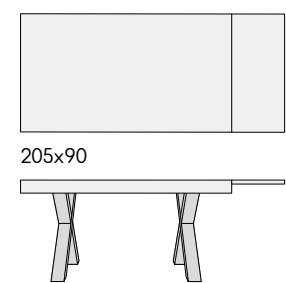
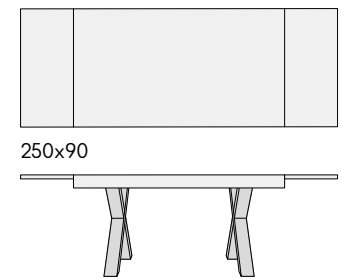

**articolo 1826**  
 tavolo allungabile nobilitato piano finitura  
 grigio cemento e base antracite 2 allunghe  
 laterali cm. 45. *extendable melamine table*  
*cement gray finishing top and anthracite*  
*base 2 extensions side cm. 45.*  
 cm. l. 160 p. 90 h. 77 colli 2 - m<sup>3</sup> 0,26  
 aperto. *open.* 250 x 90

**articolo 982**  
 sedia struttura in metallo imbottita  
 in ecopelle grigia. *chair with metal frame*  
*upholstered in in gray eco-leather.*  
 cm. l. 45 p. 42 h. 95 h.s. 48  
 non impilabile. *not stackable.*  
 colli 2 - imballo 4 pz. - m<sup>3</sup> 0,34







articolo **1828**  
 madia 4 ante ammortizzate finitura  
 acciaio ossidato. 4 amortized doors  
 sideboard oxidized steel finishing.  
 cm. l. 180 p. 50 h. 79 colli 2 - m<sup>3</sup> 0,21

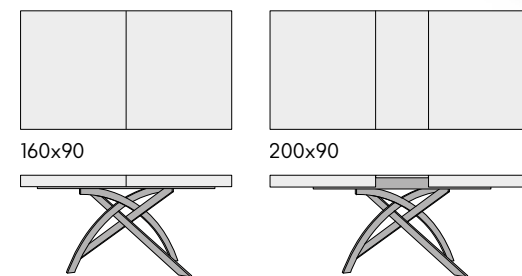
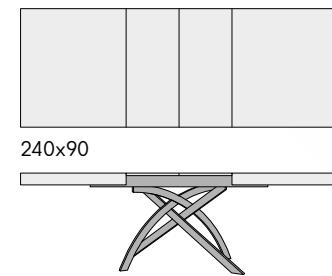

tavolo allungabile base in metallo piano  
 finitura acciaio ossidato. extendable table  
 metal base top in oxidized steel finishing.

articolo **1829** cm. 140 x 90 2 allunghe  
 centrali cm. 40. 2 central extensions cm. 40  
 aperto. open. 220 x 90 h. 77  
 colli 3 - m<sup>3</sup> 0,25

articolo **1830** cm. 160 x 90 2 allunghe  
 centrali cm. 40. 2 central extensions cm. 40  
 aperto. open. 240 x 90 h. 77  
 colli 3 - m<sup>3</sup> 0,27



articolo **04**  
 sedia struttura in metallo imbottita in  
 ecopelle antracite. chair with metal frame  
 upholstered in anthracite eco-leather.  
 cm. l. 43 p. 60 h. 83 h.s. 45  
 non impilabile. not stackable.  
 colli 1 - imballo 2 pz. - m<sup>3</sup> 0,24







articolo **1831**  
 madia 4 ante ammortizzate finitura  
 grigio cemento. 4 amortized doors  
 sideboard cement gray finishing.  
 cm. l. 180 p. 50 h. 79 colli 2 - m<sup>3</sup> 0,21

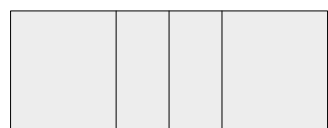

240x90

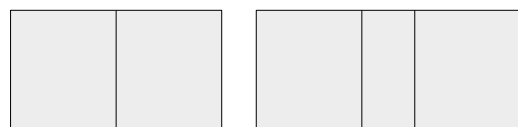
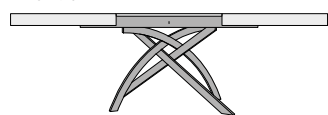

160x90

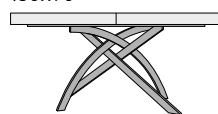

200x90

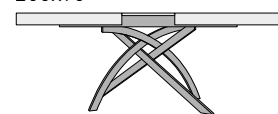

tavolo allungabile base in metallo piano  
 finitura grigio cemento. extendable table  
 metal base top in cement gray finishing.

articolo **1832** cm. 140 x 90 2 allunghe  
 centrali cm. 40. 2 central extensions cm. 40  
 aperto. open. 220 x 90 h. 77  
 colli 3 - m<sup>3</sup> 0,25

articolo **1833** cm. 160 x 90 2 allunghe  
 centrali cm. 40. 2 central extensions cm. 40  
 aperto. open. 240 x 90 h. 77  
 colli 3 - m<sup>3</sup> 0,27



articolo **1755**  
 sedia struttura in metallo imbottita  
 in ecopelle grigia. chair with metal frame  
 upholstered in gray eco-leather.  
 cm. l. 43 p. 63 h. 86 h.s. 49  
 non impilabile. not stackable.  
 colli 1 - imballo 2 pz. - m<sup>3</sup> 0,24





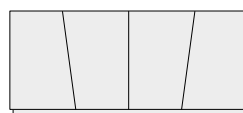
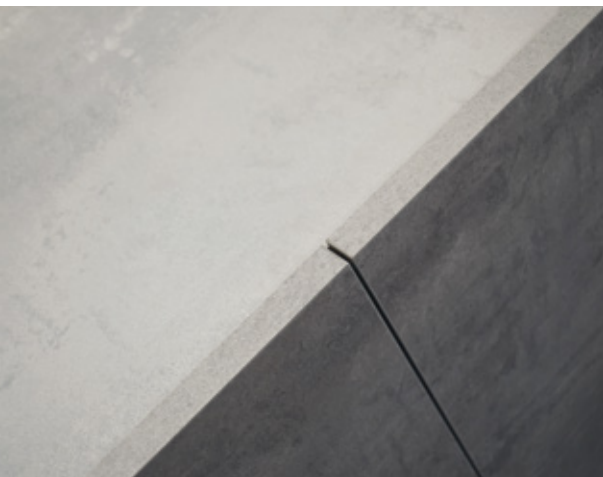

articolo **1831**  
 madia 4 ante ammortizzate finitura  
 grigio cemento. 4 amortized doors  
 sideboard cement gray finishing.  
 cm. l. 180 p. 50 h. 79 colli 2 - m<sup>3</sup> 0,21

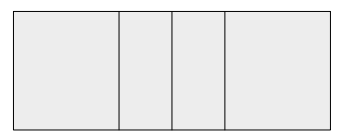

240x90

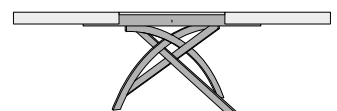

160x90

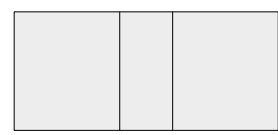

200x90

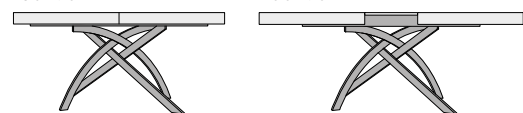

tavolo allungabile base in metallo piano  
 finitura grigio cemento. extendable table  
 metal base top in cement gray finishing.

articolo **1832** cm. 140 x 90 2 allunghe  
 centrali cm. 40. 2 central extensions cm. 40  
 aperto. open. 220 x 90 h. 77  
 colli 3 - m<sup>3</sup> 0,25

articolo **1833** cm. 160 x 90 2 allunghe  
 centrali cm. 40. 2 central extensions cm. 40  
 aperto. open. 240 x 90 h. 77  
 colli 3 - m<sup>3</sup> 0,27



articolo **1755**  
 sedia struttura in metallo imbottita  
 in ecopelle grigia. chair with metal frame  
 upholstered in gray eco-leather.  
 cm. l. 43 p. 63 h. 86 h.s. 49  
 non impilabile. not stackable.  
 colli 1 - imballo 2 pz. - m<sup>3</sup> 0,24







articolo **1834**  
 madia 4 ante ammortizzate finitura  
 bianco frassinato. 4 doors amortized  
 sideboard ash wood white finishing.  
 cm. l. 180 p. 50 h. 79 colli 2 - m<sup>3</sup> 0,21



articolo **04**  
 sedia struttura in metallo imbottita in  
 ecopelle antracite. chair with metal frame  
 upholstered in anthracite eco-leather.  
 cm. l. 43 p. 60 h. 83 h.s. 45  
 non impilabile. not stackable.  
 colli 1 - imballo 2 pz. - m<sup>3</sup> 0,24

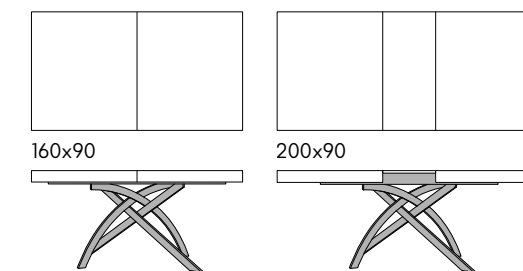
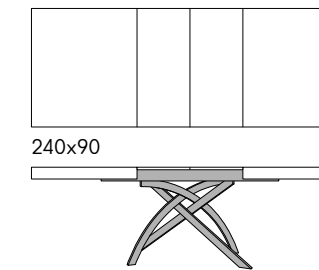

tavolo allungabile base in metallo piano  
 finitura bianco frassinato. extendable table  
 metal base top in ash wood white finishing.

articolo **1835** cm. 140 x 90 2 allunghe  
 centrali cm. 40. 2 central extensions cm. 40  
 aperto. open. 220 x 90 h. 77  
 colli 3 - m<sup>3</sup> 0,25

articolo **1836** cm. 160 x 90 2 allunghe  
 centrali cm. 40. 2 central extensions cm. 40  
 aperto. open. 240 x 90 h. 77  
 colli 3 - m<sup>3</sup> 0,27

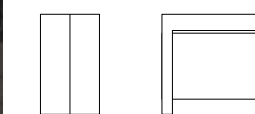
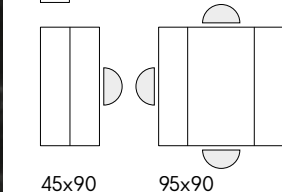
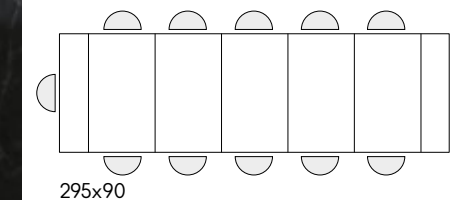

articolo **1837**  
 consolle allungabile con porta allunghe  
 finitura bianco frassinato e 5 allunghe  
 da cm. 50. extendable console  
 with extensions holder ash wood white  
 finishing and 5 extensions of cm. 50.  
 cm. l. 90 p. 45 h. 76 colli 3 - m<sup>3</sup> 0,18



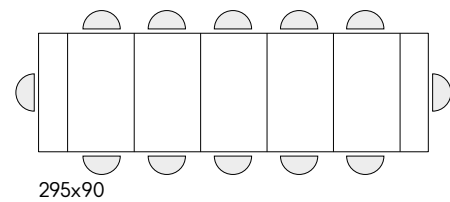

295x90



45x90

95x90

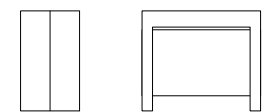

articolo **1837**  
consolle allungabile con porta allunghe  
finitura bianco frassinato e 5 allunghe  
da cm. 50. *extendable console  
with extensions holder ash wood white  
finishing and 5 extensions of cm. 50.*  
cm. l. 90 p. 45 h. 76 colli 3 - m<sup>3</sup> 0,18

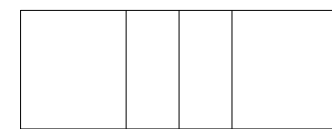

240x90

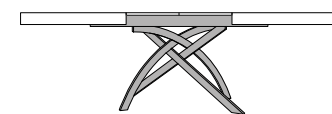

160x90

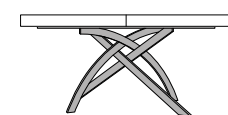

tavolo allungabile base in metallo piano  
finitura bianco frassinato. *extendable table  
metal base top in ash wood white finishing.*

articolo **1835** cm. 140 x 90 2 allunghe  
centrali cm. 40. 2 *central extensions cm. 40*  
aperto. *open.* 220 x 90 h. 77  
colli 3 - m<sup>3</sup> 0,25

articolo **1836** cm. 160 x 90 2 allunghe  
centrali cm. 40. 2 *central extensions cm. 40*  
aperto. *open.* 240 x 90 h. 77  
colli 3 - m<sup>3</sup> 0,27



articolo **04**  
sedia struttura in metallo imbottita in  
ecopelle antracite. *chair with metal frame  
upholstered in anthracite eco-leather.*  
cm. l. 43 p. 60 h. 83 h.s. 45  
non impilabile. *not stackable.*  
colli 1 - imballo 2 pz. - m<sup>3</sup> 0,24



articolo **1834**  
madia 4 ante ammortizzate finitura  
bianco frassinato. *4 doors amortized  
sideboard ash wood white finishing.*  
cm. l. 180 p. 50 h. 79 colli 2 - m<sup>3</sup> 0,21



articolo **1838**  
tavolino rettangolare struttura in metallo  
piano bianco frassinato. *rectangular coffee  
table metal structure ash wood white top.*  
cm. l. 55 p. 90 h. 45 colli 1 - m<sup>3</sup> 0,03

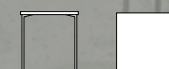

articolo **1839**  
tavolino quadrato struttura in metallo  
piano bianco frassinato. *square coffee table  
metal structure ash wood white top.*  
cm. l. 55 p. 55 h. 45 colli 1 - m<sup>3</sup> 0,02





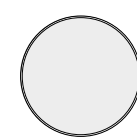

articolo **1761**  
specchiera rotonda cornice  
in metallo specchio fumè. *round mirror*  
with fumè mirror metal frame.  
cm. ø. 90 colli 1 - m³ 0,13

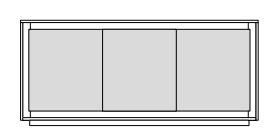

articolo **1844**  
madia 3 ante ammortizzate struttura bianco  
frassinato ante finitura grigio cemento.  
*3 amortized doors sideboard white ash wood*  
structure doors in cement gray finishing.  
cm. l. 180 p. 50 h. 80 colli 2 - m³ 0,24

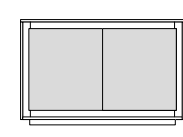

articolo **1843**  
madia 2 ante ammortizzate struttura bianco  
frassinato ante finitura grigio cemento.  
*2 amortized doors sideboard white ash wood*  
structure doors in cement gray finishing.  
cm. l. 140 p. 50 h. 80 colli 2 - m³ 0,20





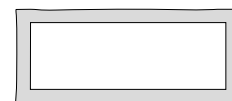

articolo **1847**  
Specchiera rettangolare cornice in vetro  
specchio bronzo fumè. *Rectangular mirror  
frame in smoked bronze mirror glass.*  
cm. l. 170 h. 67 colli 1 - m<sup>3</sup> 0,10

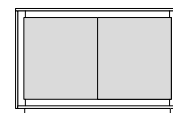

articolo **1845**  
madia 2 ante ammortizzate struttura bianco  
frassinato ante finitura acciaio ossidato.  
*2 amortized doors sideboard white ash wood  
structure doors in oxidized steel finishing.*  
cm. l. 140 p. 50 h. 80 colli 2 - m<sup>3</sup> 0,20

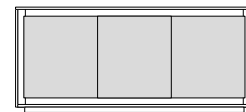

articolo **1846**  
madia 3 ante ammortizzate struttura bianco  
frassinato ante finitura acciaio ossidato.  
*3 amortized doors sideboard white ash wood  
structure doors in oxidized steel finishing.*  
cm. l. 180 p. 50 h. 80 colli 2 - m<sup>3</sup> 0,24





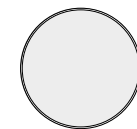

articolo **1761**  
specchiera rotonda cornice  
in metallo specchio fumè. *round mirror  
with fumè mirror metal frame.*  
cm. ø. 90 colli 1 - m<sup>3</sup> 0,13

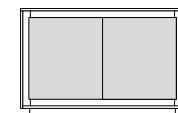

articolo **1848**  
madia 2 ante ammortizzate struttura bianco  
frassinato ante finitura rovere rustico.  
*2 amortized doors sideboard white ash wood  
structure doors in rustic oak wood finishing.*  
cm. l. 140 p. 50 h. 80 colli 2 - m<sup>3</sup> 0,20

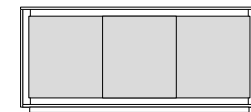

articolo **1849**  
madia 3 ante ammortizzate struttura bianco  
frassinato ante finitura rovere rustico.  
*3 amortized doors sideboard white ash wood  
structure doors in rustic oak wood finishing.*  
cm. l. 180 p. 50 h. 80 colli 2 - m<sup>3</sup> 0,24







160x90

220x90

tavolo allungabile base in metallo piano  
finitura bianco statuario. *extendable table  
metal base top in statuary white finishing.*

articolo **1809** cm. 110 x 70 1 allunga  
laterale cm. 50. *1 side extension cm. 50.*  
aperto. *open.* 160 x 70 h. 77  
colli 2 - m<sup>3</sup> 0,15

articolo **1810** cm. 120 x 80 1 allunga  
laterale cm. 50. *1 side extension cm. 50.*  
aperto. *open.* 170 x 80 h. 77  
colli 2 - m<sup>3</sup> 0,18

articolo **1811** cm. 140 x 80 1 allunga  
laterale cm. 60. *1 side extension cm. 60.*  
aperto. *open.* 200 x 80 h. 77  
colli 2 - m<sup>3</sup> 0,21

articolo **1812** cm. 160 x 90 1 allunga  
laterale cm. 60. *1 side extension cm. 60.*  
aperto. *open.* 220 x 90 h. 77  
colli 2 - m<sup>3</sup> 0,27



90x90

180x90

articolo **1818**  
tavolo a libro base in metallo piano finitura  
bianco statuario. *extendable table metal  
base top in statuary white.* cm. l. 90 p. 90  
aperto. *open.* 180 x 90 h. 77  
colli 2 - m<sup>3</sup> 0,16



articolo **1841**  
sedia in polipropilene colore grigio.  
*polypropylene chair in gray color.*  
cm. l. 46 p. 54 h. 80 h.s. 47  
impilabile. *stackable.*  
colli 1 - imballo 4 pz. - m<sup>3</sup> 0,25



articolo **1894**  
sedia in polipropilene colore bianco.  
*polypropylene chair in white color.*  
cm. l. 46 p. 54 h. 80 h.s. 47  
impilabile. *stackable.*  
colli 1 - imballo 4 pz. - m<sup>3</sup> 0,25

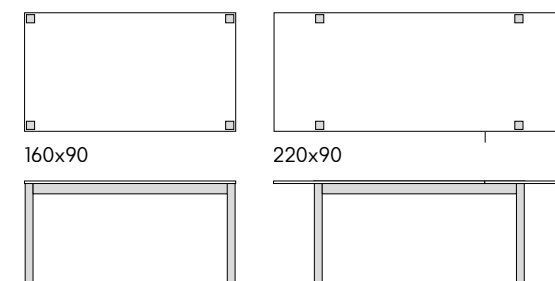

160x90

220x90

tavolo allungabile base in metallo piano  
finitura acciaio ossidato. *extendable table  
metal base top in oxidized steel finishing.*

articolo **1799** cm. 110 x 70 1 allunga  
laterale cm. 50. *1 side extension cm. 50.*  
aperto. *open.* 160 x 70 h. 77  
colli 2 - m<sup>3</sup> 0,15

articolo **1800** cm. 120 x 80 1 allunga  
laterale cm. 50. *1 side extension cm. 50.*  
aperto. *open.* 170 x 80 h. 77  
colli 2 - m<sup>3</sup> 0,18

articolo **1801** cm. 140 x 80 1 allunga  
laterale cm. 60. *1 side extension cm. 60.*  
aperto. *open.* 200 x 80 h. 77  
colli 2 - m<sup>3</sup> 0,21

articolo **1802** cm. 160 x 90 1 allunga  
laterale cm. 60. *1 side extension cm. 60.*  
aperto. *open.* 220 x 90 h. 77  
colli 2 - m<sup>3</sup> 0,27

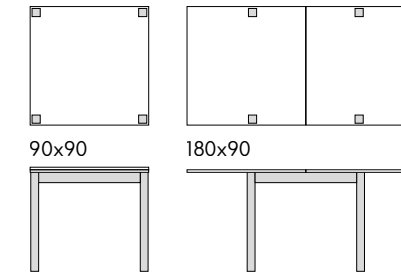

90x90

180x90

articolo **1808**  
tavolo a libro base in metallo  
piano finitura acciaio ossidato.  
*extendable table metal base top  
in oxidized steel finishing.* cm. l. 90 p. 90  
aperto. *open.* 180 x 90 h. 77  
colli 2 - m<sup>3</sup> 0,16





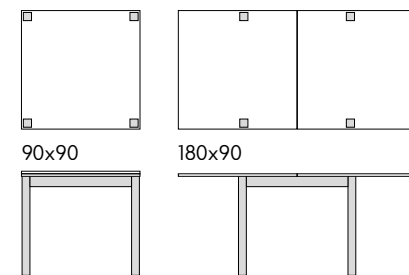

articolo **1807**  
tavolo a libro base in metallo piano  
finitura rovere rustico.  
*extendable table metal base top in rustic oak wood finishing.* cm. l. 90 p. 90  
aperto. *open.* 180 x 90 h. 77  
colli 2 - m<sup>3</sup> 0,16

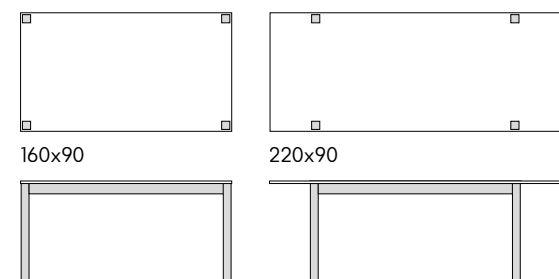

tavolo allungabile base in metallo piano  
finitura rovere rustico. *extendable table metal base top in rustic oak wood finishing.*

articolo **1803** cm. 110 x 70 l allunga  
laterale cm. 50. *l side extension cm. 50.*  
aperto. *open.* 160 x 70 h. 77  
colli 2 - m<sup>3</sup> 0,15

articolo **1804** cm. 120 x 80 l allunga  
laterale cm. 50. *l side extension cm. 50.*  
aperto. *open.* 170 x 80 h. 77  
colli 2 - m<sup>3</sup> 0,18

articolo **1805** cm. 140 x 80 l allunga  
laterale cm. 60. *l side extension cm. 60.*  
aperto. *open.* 200 x 80 h. 77  
colli 2 - m<sup>3</sup> 0,21

articolo **1806** cm. 160 x 90 l allunga  
laterale cm. 60. *l side extension cm. 60.*  
aperto. *open.* 220 x 90 h. 77  
colli 2 - m<sup>3</sup> 0,27



articolo **1842**  
sedia in polipropilene colore tortora.  
*polypropylene chair in taupe color.*  
cm. l. 46 p. 54 h. 80 h.s. 47  
impilabile. *stackable.* imballo  
colli 1 - imballo 4 pz. - m<sup>3</sup> 0,25

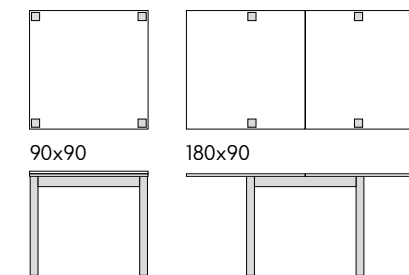

articolo **1817**  
tavolo a libro base in metallo piano  
finitura bianco frassinato.  
*extendable table metal base top ash wood white finishing.* cm. l. 90 p. 90  
aperto. *open.* 180 x 90 h. 77  
colli 2 - m<sup>3</sup> 0,16



tavolo allungabile base in metallo piano  
finitura bianco frassinato. *extendable table metal base top in ash wood white finishing.*

articolo **1813** cm. 110 x 70 l allunga  
laterale cm. 50. *l side extension cm. 50.*  
aperto. *open.* 160 x 70 h. 77  
colli 2 - m<sup>3</sup> 0,15

articolo **1814** cm. 120 x 80 l allunga  
laterale cm. 50. *l side extension cm. 50.*  
aperto. *open.* 170 x 80 h. 77  
colli 2 - m<sup>3</sup> 0,18

articolo **1815** cm. 140 x 80 l allunga  
laterale cm. 60. *l side extension cm. 60.*  
aperto. *open.* 200 x 80 h. 77  
colli 2 - m<sup>3</sup> 0,21

articolo **1816** cm. 160 x 90 l allunga  
laterale cm. 60. *l side extension cm. 60.*  
aperto. *open.* 220 x 90 h. 77  
colli 2 - m<sup>3</sup> 0,27



articolo **1895**  
sedia in polipropilene colore nero.  
*polypropylene chair in black color.*  
cm. l. 46 p. 54 h. 80 h.s. 47  
impilabile. *stackable.*  
colli 1 - imballo 4 pz. - m<sup>3</sup> 0,25



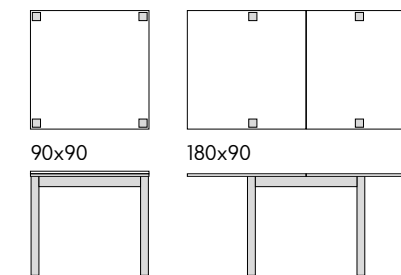

articolo **1851**  
 tavolo a libro base in metallo piano  
 finitura grigio cemento.  
*extendable table metal base top*  
*in cement gray finishing.* cm. l. 90 p. 90  
 aperto. *open.* 180 x 90 h. 77  
 colli 2 - m<sup>3</sup> 0,16

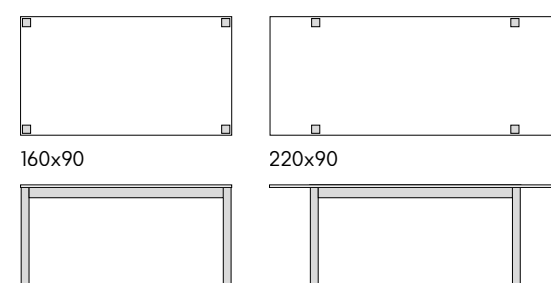

tavolo allungabile base in metallo piano  
 finitura grigio cemento. *extendable table*  
*metal base top in cement gray finishing.*

articolo **1852** cm. 110 x 70 l allunga  
 laterale cm. 50. *l side extension cm. 50.*  
 aperto. *open.* 160 x 70 h. 77  
 colli 2 - m<sup>3</sup> 0,15

articolo **1853** cm. 120 x 80 l allunga  
 laterale cm. 50. *l side extension cm. 50.*  
 aperto. *open.* 170 x 80 h. 77  
 colli 2 - m<sup>3</sup> 0,18

articolo **1854** cm. 140 x 80 l allunga  
 laterale cm. 60. *l side extension cm. 60.*  
 aperto. *open.* 200 x 80 h. 77  
 colli 2 - m<sup>3</sup> 0,21

articolo **1855** cm. 160 x 90 l allunga  
 laterale cm. 60. *l side extension cm. 60.*  
 aperto. *open.* 220 x 90 h. 77  
 colli 2 - m<sup>3</sup> 0,27



articolo **713**  
 sedia struttura in metallo imbottita  
 in ecopelle grigia. *chair with metal frame*  
*upholstered in gray eco-leather.*  
 cm. l. 43 p. 53 h. 92 h.s. 44  
 impilabile. *stackable.*  
 colli 1 - imballo 4 pz. - m<sup>3</sup> 0,30







articolo **07**  
 sedia struttura in metallo imbottita in ecopelle antracite. *chair with metal frame upholstered in anthracite eco-leather.*  
 cm. l. 40 p. 47 h. 82 h.s. 52  
 non impilabile. *not stackable.*  
 colli 1 - imballo 2 pz. - m<sup>3</sup> 0,20



articolo **04**  
 sedia struttura in metallo imbottita in ecopelle antracite. *chair with metal frame upholstered in anthracite eco-leather.*  
 cm. l. 43 p. 60 h. 83 h.s. 45  
 non impilabile. *not stackable.*  
 colli 1 - imballo 2 pz. - m<sup>3</sup> 0,24



articolo **1914**  
 sedia struttura in metallo imbottita in velluto grigio. *chair with metal structure upholstered in gray velvet.*  
 cm. l. 43 p. 48 h. 84 h.s. 46  
 non impilabile. *not stackable.*  
 colli 1 - imballo 4 pz. - m<sup>3</sup> 0,32



articolo **1905**  
 sedia struttura e seduta in legno naturale. *chair with structure and seat in natural wood.*  
 cm. l. 44 p. 42 h. 86 h.s. 46  
 impilabile. *stackable.*  
 colli 1 - imballo 1 pz. - m<sup>3</sup> 0,08



articolo **1755**  
 sedia struttura in metallo imbottita in ecopelle grigia. *chair with metal frame upholstered in gray eco-leather.*  
 cm. l. 43 p. 63 h. 86 h.s. 49  
 non impilabile. *not stackable.*  
 colli 1 - imballo 2 pz. - m<sup>3</sup> 0,24



articolo **1756**  
 sedia struttura in metallo imbottita in ecopelle beige. *chair with metal frame upholstered in beige eco-leather.*  
 cm. l. 43 p. 63 h. 86 h.s. 49  
 non impilabile. *not stackable.*  
 colli 1 - imballo 2 pz. - m<sup>3</sup> 0,24



articolo **1753**  
 sedia struttura in legno seduta imbottita in tessuto. *chair with wooden structure upholstered seat in fabric*  
 cm. l. 51 p. 55,5 h. 89 h.s. 45  
 non impilabile. *not stackable.*  
 colli 1 - imballo 2 pz. - m<sup>3</sup> 0,09



articolo **10**  
 Sgabello struttura in metallo imbottita in ecopelle antracite. *Stool with metal frame upholstered in anthracite eco-leather.*  
 cm. l. 36 p. 44 h. 100 h.s. 76  
 non impilabile. *not stackable.*  
 colli 1 - imballo 2 pz. - m<sup>3</sup> 0,22



articolo **06**  
 sedia struttura in metallo imbottita in ecopelle marrone. *chair with metal frame upholstered in brown eco-leather.*  
 cm. l. 40 p. 47 h. 82 h.s. 52  
 non impilabile. *not stackable.*  
 colli 1 - imballo 2 pz. - m<sup>3</sup> 0,20



articolo **03**  
 sedia struttura in metallo imbottita in ecopelle marrone. *chair with metal frame upholstered in brown eco-leather.*  
 cm. l. 43 p. 60 h. 83 h.s. 45  
 non impilabile. *not stackable.*  
 colli 1 - imballo 2 pz. - m<sup>3</sup> 0,24



articolo **1915**  
 sedia struttura in metallo imbottita in velluto grigio. *chair with metal structure upholstered in gray velvet.*  
 cm. l. 53 p. 63 h. 84 h.s. 46  
 non impilabile. *not stackable.*  
 colli 2 - imballo 4 pz. - m<sup>3</sup> 0,47



articolo **1904**  
 sedia struttura e seduta in legno bianco consumato. *chair with structure and seat in worn white wood.*  
 cm. l. 44 p. 42 h. 86 h.s. 46  
 impilabile. *stackable.*  
 colli 1 - imballo 1 pz. - m<sup>3</sup> 0,08



articolo **711**  
 sedia struttura in metallo imbottita in ecopelle nera. *chair with metal frame upholstered in black eco-leather.*  
 cm. l. 43 p. 53 h. 92 h.s. 44  
 impilabile. *stackable.*  
 colli 1 - imballo 4 pz. - m<sup>3</sup> 0,30



articolo **713**  
 sedia struttura in metallo imbottita in ecopelle grigia. *chair with metal frame upholstered in gray eco-leather.*  
 cm. l. 43 p. 53 h. 92 h.s. 44  
 impilabile. *stackable.*  
 colli 1 - imballo 4 pz. - m<sup>3</sup> 0,30



articolo **709**  
 sedia struttura in metallo imbottita in ecopelle bianca. *chair with metal frame upholstered in white eco-leather.*  
 cm. l. 43 p. 53 h. 92 h.s. 44  
 impilabile. *stackable.*  
 colli 1 - imballo 4 pz. - m<sup>3</sup> 0,30



articolo **710**  
 sedia struttura in metallo imbottita in ecopelle tortora. *chair with metal frame upholstered in taupe eco-leather.*  
 cm. l. 43 p. 53 h. 92 h.s. 44  
 impilabile. *stackable.*  
 colli 1 - imballo 4 pz. - m<sup>3</sup> 0,30



articolo **1752**  
 sedia struttura in legno colore bianco e seduta in ecopelle nera. *chair structure in white wood color and seat in black eco-leather.* cm. l. 48 p. 45,5 h. 79 h.s. 46  
 non impilabile. *not stackable.*  
 colli 1 - imballo 2 pz. - m<sup>3</sup> 0,09



articolo **1748**  
 sedia struttura in legno naturale e seduta in ecopelle nera. *chair structure in natural wood and seat in black eco-leather.* cm. l. 48 p. 45,5 h. 79 h.s. 46  
 non impilabile. *not stackable.*  
 colli 1 - imballo 2 pz. - m<sup>3</sup> 0,09



articolo **1751**  
 sedia struttura in legno colore grigio e seduta in ecopelle nera. *chair structure in gray wood color and seat in black eco-leather.* cm. l. 48 p. 45,5 h. 79 h.s. 46  
 non impilabile. *not stackable.*  
 colli 1 - imballo 2 pz. - m<sup>3</sup> 0,09



articolo **1750**  
 sedia struttura in legno colore tortora e seduta in ecopelle nera. *chair structure in sea green wood color and seat in black eco-leather.* cm. l. 48 p. 45,5 h. 79 h.s. 46  
 non impilabile. *not stackable.*  
 colli 1 - imballo 2 pz. - m<sup>3</sup> 0,09



articolo **1749**  
 sedia struttura in legno colore verde mare e seduta in ecopelle nera. *chair structure in sea green wood color and seat in black eco-leather.* cm. l. 48 p. 45,5 h. 79 h.s. 46  
 non impilabile. *not stackable.*  
 colli 1 - imballo 2 pz. - m<sup>3</sup> 0,09



articolo **764**  
 sedia struttura in legno seduta in polipropilene con cuscino in ecopelle. *chair structure in wood seat in polypropylene with eco-leather cushion.*  
 cm. l. 55 p. 48 h. 82 h.s. 47  
 non impilabile. *not stackable.*  
 colli 1 - imballo 2 pz. - m<sup>3</sup> 0,13



articolo **695**  
 sedia in polipropilene trasparente. *transparent polypropylene chair*  
 cm. l. 50,5 p. 48,5 h. 94 h.s. 46  
 impilabile. *stackable.*  
 colli 1 - imballo 4 pz. - m<sup>3</sup> 0,30



articolo **982**  
 sedia struttura in metallo imbottita in ecopelle grigia. *chair with metal frame upholstered in gray eco-leather.*  
 cm. l. 45 p. 42 h. 95 h.s. 48  
 non impilabile. *not stackable.*  
 colli 2 - imballo 4 pz. - m<sup>3</sup> 0,34





articolo **1894**  
sedia in polipropilene colore bianco.  
*polypropylene chair in white color.*  
cm. l. 46 p. 54 h. 80 h.s. 47  
impilabile. *stackable.*  
colli 1 - imballo 4 pz. - m<sup>3</sup> 0,25



articolo **1841**  
sedia in polipropilene colore grigio.  
*polypropylene chair in gray color.*  
cm. l. 46 p. 54 h. 80 h.s. 47  
impilabile. *stackable.*  
colli 1 - imballo 4 pz. - m<sup>3</sup> 0,25



articolo **1895**  
sedia in polipropilene colore nero.  
*polypropylene chair in black color.*  
cm. l. 46 p. 54 h. 80 h.s. 47  
impilabile. *stackable.*  
colli 1 - imballo 4 pz. - m<sup>3</sup> 0,25



articolo **1842**  
sedia in polipropilene colore tortora.  
*polypropylene chair in taupe color.*  
cm. l. 46 p. 54 h. 80 h.s. 47  
impilabile. *stackable.*  
colli 1 - imballo 4 pz. - m<sup>3</sup> 0,25



articolo **1923**  
poltrona struttura in metallo rivestita  
in velluto grigio. *armchair with metal  
structure covered in gray velvet.*  
cm. l. 74 p. 67 h. 99 h.s. 46,5  
non impilabile. *not stackable.*  
colli 1 - imballo 1 pz. - m<sup>3</sup> 0,22



articolo **1924**  
poltrona struttura in metallo rivestita  
in velluto grigio. *armchair with metal  
structure covered in gray velvet.*  
cm. l. 72,5 p. 87,5 h. 78 h.s. 50,5  
non impilabile. *not stackable.*  
colli 1 - imballo 1 pz. - m<sup>3</sup> 0,28



articolo **990**  
sedia struttura in metallo e seduta  
in polipropilene colore bianco.  
*chair with metal structure and seat  
in white color polypropylene.*  
cm. l. 52,5 p. 48 h. 88 h.s. 46  
non impilabile. *not stackable.*  
colli 1 - imballo 4 pz. - m<sup>3</sup> 0,16



articolo **991**  
sedia struttura in metallo e seduta  
in polipropilene colore grigio.  
*chair with metal structure and seat  
in gray color polypropylene.*  
cm. l. 52,5 p. 48 h. 88 h.s. 46  
non impilabile. *not stackable.*  
colli 1 - imballo 4 pz. - m<sup>3</sup> 0,16



articolo **992**  
sedia struttura in metallo e seduta  
in polipropilene colore tortora.  
*chair with metal structure and seat  
in taupe color polypropylene.*  
cm. l. 52,5 p. 48 h. 88 h.s. 46  
non impilabile. *not stackable.*  
colli 1 - imballo 4 pz. - m<sup>3</sup> 0,16



articolo **1921**  
sedia struttura in legno colore antracite  
imbottita in ecopelle antracite.  
*chair structure in anthracite wood color  
upholstered in anthracite eco-leather.*  
cm. l. 46 p. 45 h. 100 h.s. 46  
non impilabile. *not stackable.*  
colli 1 - imballo 2 pz. - m<sup>3</sup> 0,34



articolo **1925**  
poltrona struttura in metallo rivestita  
in velluto grigio. *armchair with metal  
structure covered in gray velvet.*  
cm. l. 53 p. 47 h. 82 h.s. 47  
non impilabile. *not stackable.*  
colli 1 - imballo 2 pz. - m<sup>3</sup> 0,21



articolo **1926**  
sedia struttura in metallo rivestita  
in velluto grigio. *chair with metal  
structure covered in gray velvet.*  
cm. l. 49 p. 44 h. 82 h.s. 49  
non impilabile. *not stackable.*  
colli 1 - imballo 4 pz. - m<sup>3</sup> 0,29



articolo **1761**  
specchiera rotonda cornice  
in metallo specchio fumè. *round mirror  
with fumè mirror metal frame.*  
cm. ø. 90 colli 1 - m<sup>3</sup> 0,13



articolo **1787**  
specchiera rettangolare cornice  
in vetro effetto marmo. *rectangular mirror  
frame in marble effect glass.*  
cm. l. 68 h. 90 colli 1 - m<sup>3</sup> 0,05



articolo **969**  
sedia struttura e seduta in polipropilene  
colore bianco. *chair structure and seat  
in polypropylene white color.*  
cm. l. 50 p. 53 h. 81 h.s. 46  
impilabile. *stackable.*  
colli 1 - imballo 4 pz. - m<sup>3</sup> 0,24



articolo **970**  
sedia struttura e seduta in polipropilene  
colore grigio. *chair structure and seat  
in polypropylene gray color.*  
cm. l. 50 p. 53 h. 81 h.s. 46  
impilabile. *stackable.*  
colli 1 - imballo 4 pz. - m<sup>3</sup> 0,24



articolo **971**  
sedia struttura e seduta in polipropilene  
colore tortora. *chair structure and seat  
in polypropylene taupe color.*  
cm. l. 50 p. 53 h. 81 h.s. 46  
impilabile. *stackable.*  
colli 1 - imballo 4 pz. - m<sup>3</sup> 0,24



articolo **1922**  
sedia struttura in legno colore tortora  
scuro imbottita in ecopelle tortora.  
*chair structure in taupe wood color  
upholstered in taupe eco-leather.*  
cm. l. 46 p. 45 h. 100 h.s. 46  
non impilabile. *not stackable.*  
colli 1 - imballo 2 pz. - m<sup>3</sup> 0,34

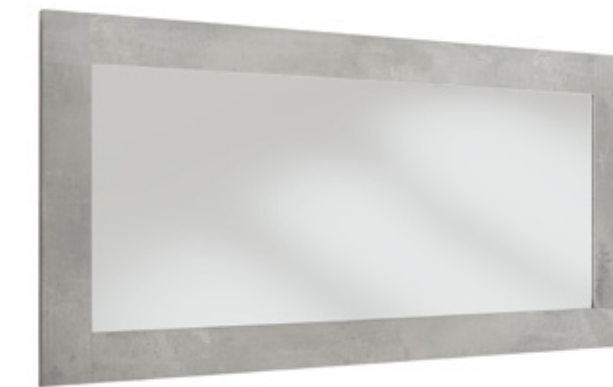

articolo **1793**  
Specchiera rettangolare con cornice  
grigio cemento. *rectangular mirror  
with cement gray frame.*  
cm. l. 177 h. 86 colli 1 - m<sup>3</sup> 0,12



articolo **1847**  
Specchiera rettangolare cornice in vetro  
specchio bronzo fumè. *Rectangular mirror  
frame in smoked bronze mirror glass.*  
cm. l. 170 h. 67 colli 1 - m<sup>3</sup> 0,10